

The Akhenaten Theorem

and the

The Joses Revelation of Universal Physics

Paper 7

Chris G.

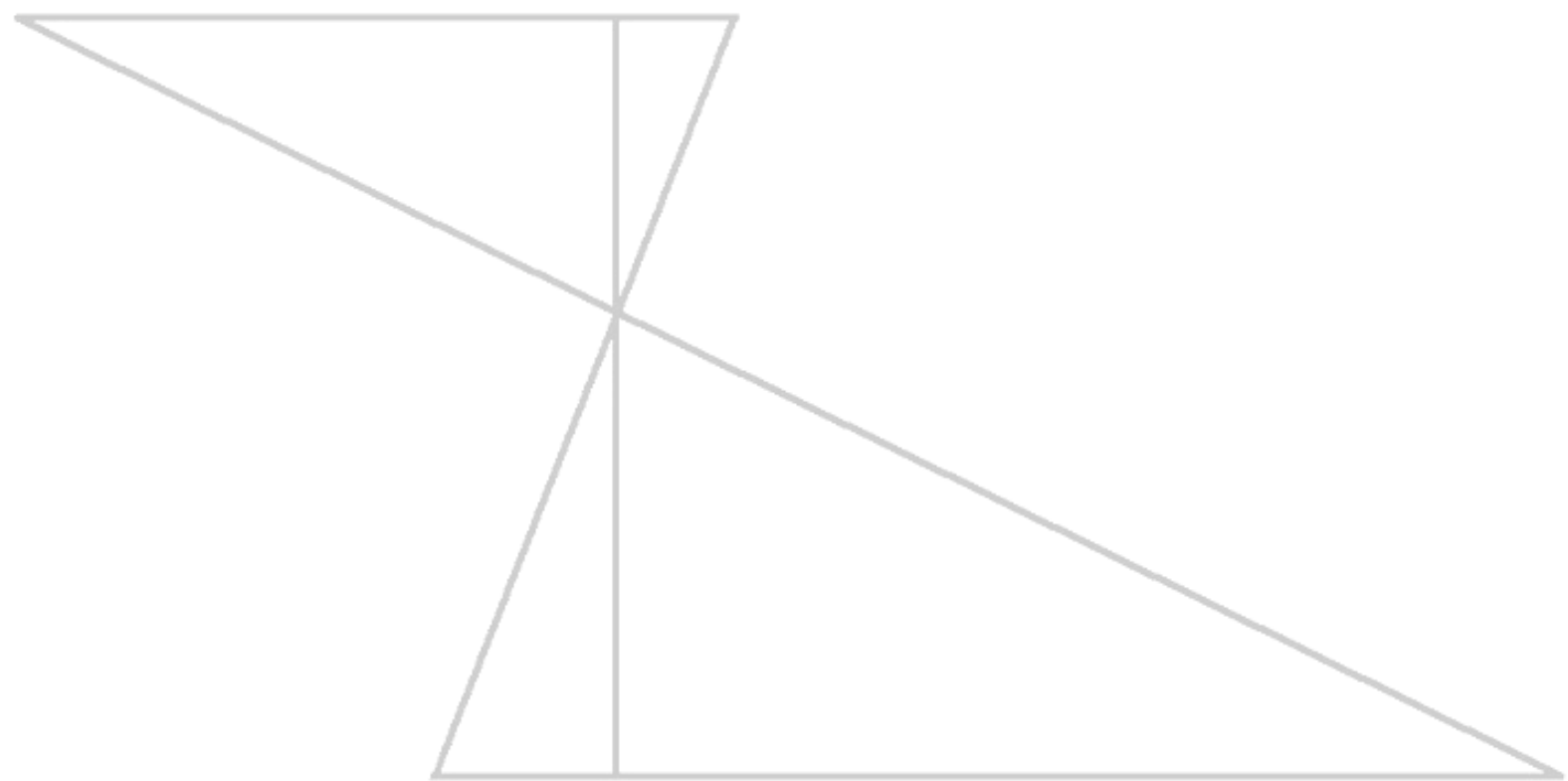

The Akhenaten Theorem and the The Joses Revelation of Universal Physics, Paper 7

Copyright © 2021 Chris G.

First Published 2013, Second 2018

Entire Contents ©Copyright 2021 by Chris G. Copyright under the Copyright Act 1968
All rights reserved.

No part of this publication may be reproduced, stored in a retrieval system or transmitted in any form or by any means, electronic, mechanical, photocopying, recording or otherwise, without the prior written permission of the author.
All Material and Subject Matter in this Publication was written and compiled by Chris G., and is the Intellectual Property of Chris G.

The Akhenaten Theorem and the The Joses Revelation of Universal Physics, Paper 7 is the Intellectual and Physical Property of Chris G.

The information, views, opinions and visuals expressed in this publication are solely those of the author and do not reflect those of the publisher. The publisher and the author disclaims any liabilities or responsibilities whatsoever for any damages, libel or liabilities arising directly or indirectly from the contents of this publication.

All images are copyright to their respective owners.
Straight Eight symbol - copyright Chris G.

Published by Blak Soil Publications Perth, Western Australia

v1.3

Introduction

My name is Chris G., and within the Paper attached I present my own personal knowledge of Universal Physics.

While working Night-shift on a Mine Site in the remote Pilbara Region of Western Australia, in between operating Wheel-dozers, Haul Trucks, and Loaders, I conceived and wrote this Paper over the course of seven nights from the 5th - 11th of June 2013.

As I was working a Fly-In/Fly-Out 1&1 roster, I was flying to Site from my home City of Perth, Western Australia. The early morning 3am start had me feeling very tired, and as the plane was about to land I was somewhere adrift between awake and asleep; and in this state of consciousness I had a revelation of the Universe in my mind's eye. Upon landing, a simple Riddle with a simple answer came to mind; which is presented at the start of the Paper.

Here, I state a new Physics Theory that is far removed from Classical, Traditional, Conventional, and New-age Theoretical and Accepted Physics. I am stating 'Sphere Theory' via 'The Joses Revelation of Universal Physics'.

Many people, especially Physicists, may be offended at many of my claims and theories I present in this Paper, as such claims and theories often are opposed to many of the most famous Theories and renowned Physicists and Scientists. In reality though, Physics does not cater to Egos and Pride, and is infinitely greater than a 'dot' in the Universe that is Planet Earth and Humanity.

Another reality that the Scientific Communities and Religious Collectives will need to accept, and also the rest of the entire World, is that Science and God are intricately combined, with God as the source. Everyone knew that a time was coming, and is now here, when Humanity would need to except that Science and the Supernatural were not indifferent to each other. Much of that which Science, over the past centuries, has defiantly believed it could explain is still far from resolved; and much of that which Religion has either ignorantly thought to be of 'The Devil', or arrogantly thought to be Supernatural, has been corrected by Science.

I am not on a quest to unite Science and God, but rather a man who likes to ponder from time to time on deeper issues other than the superficial and, at times, silly and immature topics such as War, Religion, Racism, Politics, and any other interest that divides Humanity; I seek Truth only.

I will not be bound and censored by Tradition within Science and Religion!

Whether the Reader agrees, in part or full, with that which I have written is not as important as reading this Paper in its entirety; the act of 'acknowledging and hearing' another person's thoughts, ideas, and opinions; this is an act of Respect and a sign of a willingness to examine all the information before forming an opinion and a response.

So, thanks for giving me the opportunity to share my Thoughts.

Chris G.

June 2013

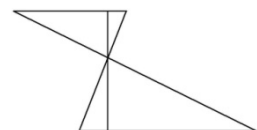

The Joses Revelation of Universal Physics

'The Joses Revelation of Universal Physics' is better realized when asked a simple Question; in fact, a Riddle - as the answer is not disclosed.

If there are two people who were born at the exact same moment; and are therefore now the exact same age to within the hour, to within the minute, to within the second, and to within a one-hundredth of a second; how is it then possible that they were born on different days and at different times?

There are those that may consider the above Riddle as an insult to their intelligence; however, the "Revelation" is not found within the simplicity of the short logical answer, but rather gained by the process of analyzing the 'Laws of Physics' and the 'Rules of Man' that force the 'answer' to be that which it is. The Riddle and the Answer are constructed with Variables that are only relevant to the Revelation in as much as the Variables create the Riddle and subsequent Answer as a means to realize the Revelation.

Within the Revelation is the understanding that Time is irrelevant.

Time is irrelevant to all that is seen and unseen, and not a governing element, and thus does not exist!

Joses' 'Law of Time' is thus;

'Time' is a Theory!

('Time' is 'Theoretical Physics' in its most poorest state; only serves Mankind's need for Control!)

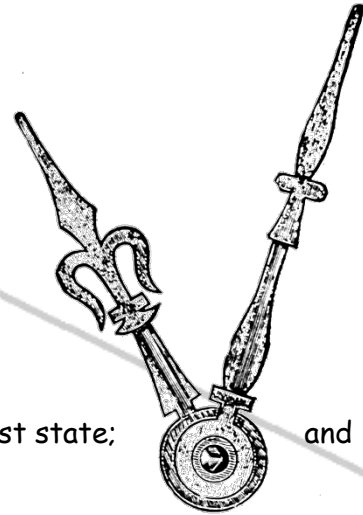

Thus, any 'Laws', 'Understandings', or 'Theories' that involve Time as an element are considered void.

Human 'Age' is not governed by 'Time', but rather by 'Change'; as found within 'The Joses Theory of Spheres' - "Sphere Theory"

'Sphere Theory' is the theory that all that is seen, and unseen is composed of particles that govern all that is within the Universe - these particles are call "Particle Spheres".

Particle Spheres

'Particle Spheres' are spheres of 'Thought' that hold Mass and Density.

Particle Spheres in their most basic form (Natural), as defined as that which does not change, are only governed by other Particle Spheres within 'Reaction'.

Joses' 'First Law of Reaction' is thus;
Other than the 'Initial Action' there is no Action, but only Reaction -
Action is Reaction!

Joses' 'Second Law of Reaction' is thus;
For every Reaction there is an equal Reaction of the same force.
(The energy of a subsequent Reaction may be clustered or dispersed)

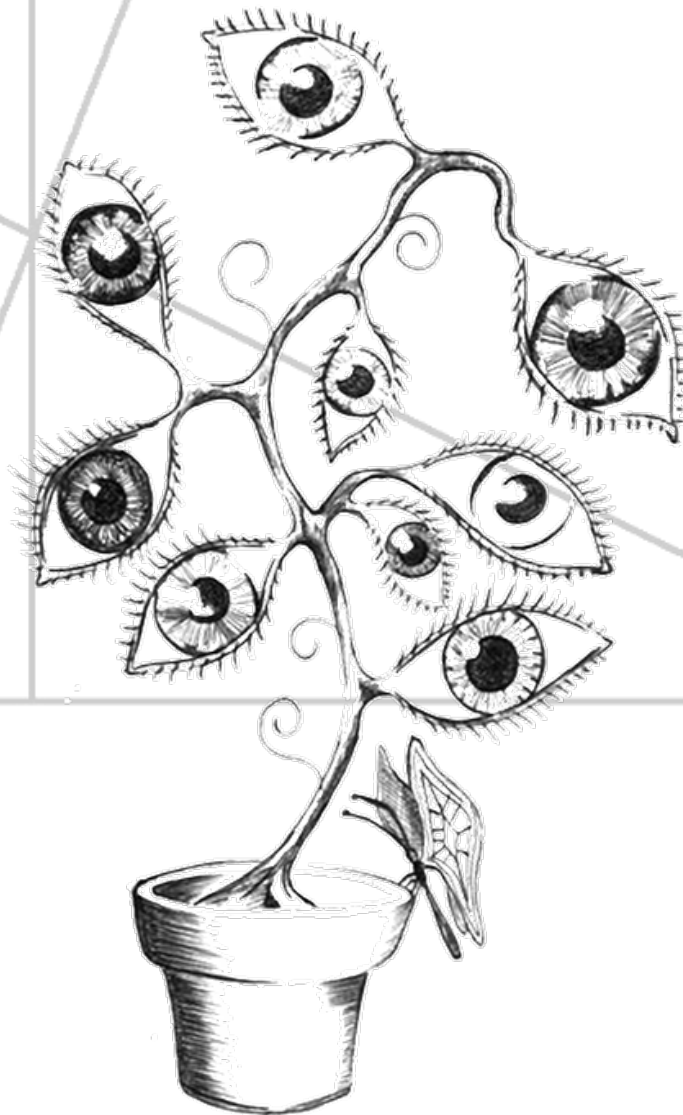

A singular Particle Sphere has three (3) states of being:

Condensed:

Radius = at its smallest Radius of 'X'
Volume = at its least Volume of 'X'
Mass = remains the same at 'X'
Density = 100% at 'X'

In this state, the properties of a singular Particle Sphere cannot be recognized nor calculated.

Natural:

Radius = at its natural Radius of 'X'
Volume = at its natural Volume of 'X'
Mass = remains the same at 'X'
Density = at its natural Density of 'X'

In this state, the properties of a singular Particle Sphere cannot be recognized nor calculated.

Expanded:

Radius = variable unto infinity (∞)
Volume = variable unto infinity (∞); limited only by
the relevant Radius.
Mass = remains the same at 'X'
Density = variable unto infinity (∞); limited only by
the relevant Radius.

In this state, depending on the expansion degree, the properties of a singular Particle Sphere can be recognized and calculated. However, if this state is such that the Particle Sphere is too small (eg. near a Natural state/size) or too large (eg. the Universe) then it will not be recognizable nor calculable.

In between these three (3) states; namely, in between the two stages of 100% Density up until maximum Radius, there are all other changing states.

The quality (q) of a Particle Sphere is calculable by the total sum of its four (4) physical properties - Radius (r), Volume (V), Mass (m), and Density (p); and such 'quality' is measured in 'minutons (mn)'.

Example 1: a random Particle Sphere:

$$\begin{aligned} r &= d/2 \\ &= 8/2 \\ &= 4\text{m} \end{aligned}$$

$$\begin{aligned} V &= 4/3 \cdot \pi \cdot r^3 \\ &\approx 4/3 \cdot 3.14 \cdot (4\text{m})^3 \\ &\approx 4/3 \cdot 3.14 \cdot 64\text{m}^3 \\ &\approx 4.19 \cdot 64\text{m}^3 \\ &\approx 268.16\text{m}^3 \end{aligned}$$

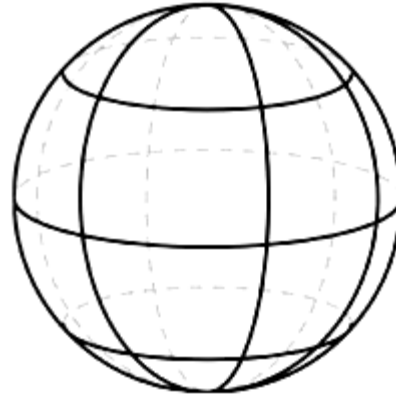

$$m = 10\text{kg}$$

$$\begin{aligned} p &= \text{mass}/v \\ &\approx 10/268.16^3 \\ &\approx 0.03\text{kg}/\text{m}^3 \end{aligned}$$

$$\begin{aligned} q &= r + V + m + p \\ &\approx 4 + 268.16 + 10 + 0.03 \\ &\approx 282.19\text{mn} \end{aligned}$$

Thus, the quality (q) of Example 1 is found to be about $\approx 282\text{mn}$

Particle Spheres in their most basic form, and at their smallest quality (q) are thus at their shortest Radius (r), least Volume (V), lowest Density (p), and lightest Mass.

Any one Particle Sphere can increase or decrease any singular property, but only at the expense of the remaining properties (Exception: The Mass of a Particle Sphere never changes); this rule is one part of that which is known as 'The Laws of Particle Spheres'.

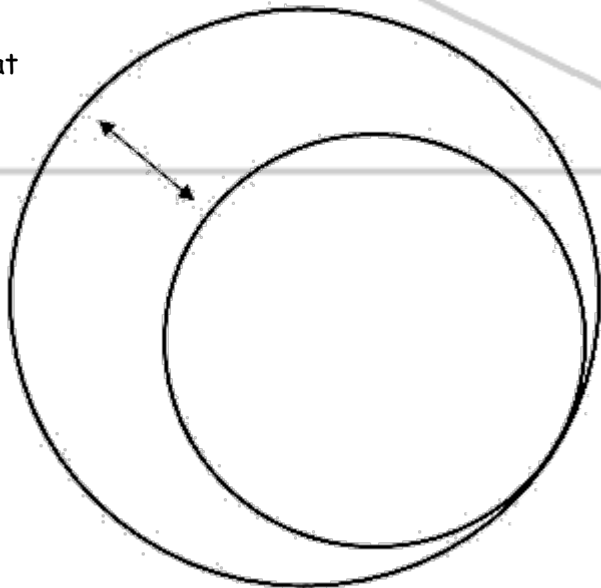

The Laws of Particle Spheres

1. The Radius and Volume of any one singular Particle Sphere can be increased, but only if the Density is decreased at the same percentage; or the Radius and Volume can be decreased, but only if the Density is increased at the same percentage.
2. The Density of any one singular Particle Sphere can be increased, but only if the Radius and Volume is decreased at the same percentage; or the Density can be decreased, but only if the Radius and Volume is increased at the same percentage.
3. The Mass of any one singular Particle Sphere never changes.
4. Particle Spheres may combine or cluster;
Combine: to merge as to become one.
Cluster: to be in close proximity as to overlap.
5. When any two Particle Spheres combine then the Mass is doubled, but the value of Density and Volume are subject to the Radius, and are equal opposites to the Radius to a maximum of double the value of the radius of one singular Particle Sphere.
6. Two or more Particle Spheres may combine to form a singular larger Sphere, or a singular same size Sphere with more Density and Mass.
7. A combined singular larger Sphere may embody one or more smaller combined/clustered Spheres and/or singular Spheres.



Figure 1: a Human Particle Sphere for person 2m in height and weighs 100kg:

$$\begin{aligned} r &= d/2 \\ &= 2/2 \\ &= 1\text{m} \end{aligned}$$

$$\begin{aligned} V &= 4/3 \cdot \pi \cdot r^3 \\ &\approx 4/3 \cdot 3.14 \cdot (1\text{m})^3 \\ &\approx 4/3 \cdot 3.14 \cdot 1\text{m}^3 \\ &\approx 4.19 \cdot 1\text{m}^3 \\ &\approx 4.19\text{m}^3 \end{aligned}$$

$$m = 100\text{kg}$$

$$\begin{aligned} p &= \text{mass}/v \\ &\approx 100/4.19^3 \\ &\approx 23.86\text{kg}/\text{m}^3 \end{aligned}$$

$$\begin{aligned} q &= r + V + m + p \\ &\approx 1 + 4.19 + 100 + 23.86 \\ &\approx 129.05\text{mn} \end{aligned}$$

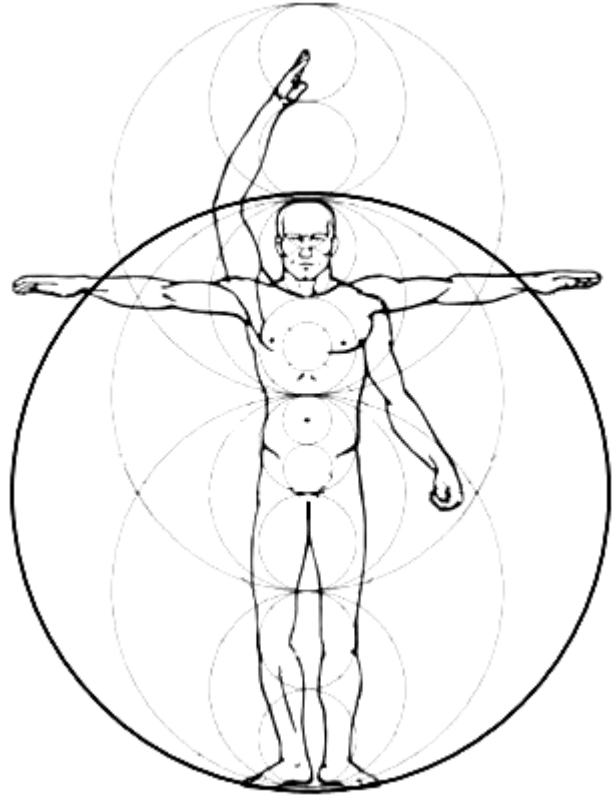

Thus, the quality (q) of this Individual is found to be about $\approx 129\text{mn}$

The quality (q) of the Individual is the total of all the Particle Spheres embodies within the 'Host Particle Sphere'.

(Host Particle Sphere - Any Particle Sphere that embodies one or more other Particle Spheres. The Super-Sphere (Universe) is the only Sphere that cannot obviously be Hosted.)

The Super-Sphere

The Super-Sphere is literally the Universe, and is simply a Particle Sphere that has been expanded to its largest extreme (when in comparison to all other Particle Spheres).

All other Particle Spheres exist within the Super-Sphere.

Within our known Super-Sphere (Universe) there is an unknown large quantity of 'Super-Clusters' (Galaxies) that embody an even larger number of 'Minor-Spheres' (Solar-Systems); and embodied within Minor-Spheres are 'Sun-Spheres' (Suns), and 'Orbital-Spheres' (Bodies that revolve around Sun-Spheres), and 'Minor Orbital-Spheres' (Bodies that revolve around Orbital Spheres).

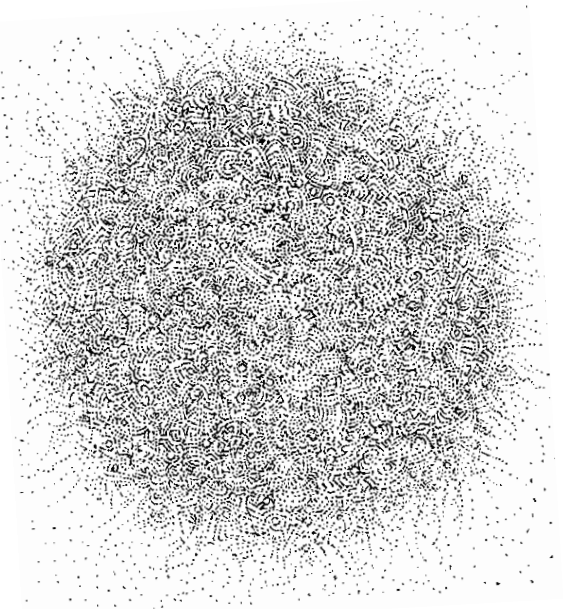

Gravity and Particle Spheres

Particle Spheres are subject to 'The Laws of Gravity'; however, Gravity only exists as one property of Particle Spheres. Thus, it is further understood that larger combined/clusters of Particle Spheres attract smaller combined/clusters of Particle Spheres and singular Particle Spheres; furthermore, all singular Particle Spheres and combined/clusters of Particle Spheres produce the property of Gravity.

Vacuum and Particle Spheres

Vacuum (or Negative Space) does not exist.

That which is defined as Vacuum by General Physics is in fact combined Particle Spheres and singular Particle Spheres that are expanded and low in Density.

Light and Particle Spheres

Particle Spheres emit, absorb, and create Light; they are also transparent in that Light can pass through them, depending on the density of any combined Particle Sphere or singular Particle Sphere.

As Particle Spheres Condense, Expand, Merge and Divide they create Friction, Vibrations, Heat, and Light.

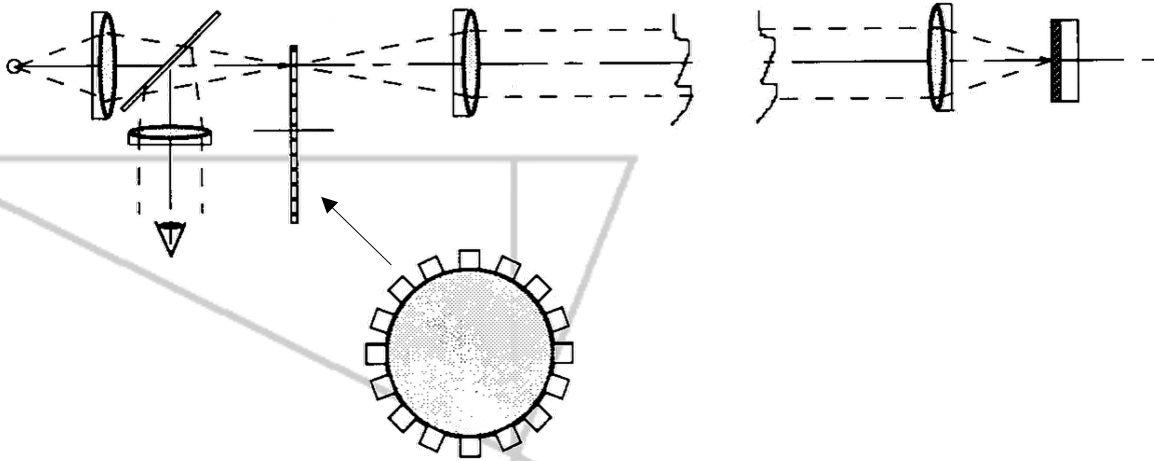

Instructions of Particle Spheres

Particle Spheres are spheres of 'Thought'; and as such they have 'Internal Instructions' that govern their movements and nature.

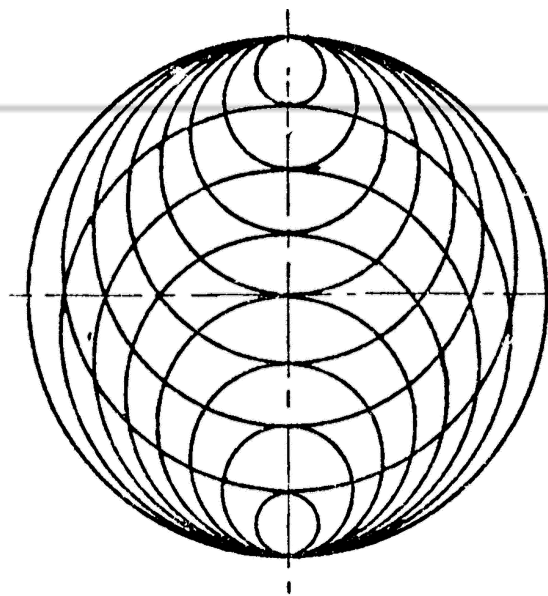

God and Particle Spheres

Does God exist? YES!!!

Nothing is created without first imagining it - including Particle Spheres!

Particle Spheres are God, and are from God, and are within God.

Humans question the existence of God after visually assessing their surroundings and perceiving imperfection within such. However, that which is perceived to be "Imperfection" is simply a misunderstanding by Humans, much the same as "Perfection". Neither Perfection nor Imperfection exists; and much the same as 'Time', Perfection and Imperfection are perceptions that Humans create as a substitution for psychological deficiencies.

The Same way we find Freedom within Suffering, we also find Beauty within Imperfection; because within Imperfection we are allowed to use our Imaginations - to dream of Perfection, and our own personal role within that dream.

What Humans perceive to be Imperfection was found to be a necessity for the collective and Individual Consciousness of the Universe to survive.



Time and Particle Spheres

Sphere Theory is conclusive in stating that the element of 'Time' does not exist; and that any preexisting Physics 'Theories' and Laws that require the element of Time in their equations are thus pronounced void; furthermore, this states that Time-travel is not possible.

Time and Speed

Question: If 'Time' does not exist then how is 'Speed' to be measured?

Answer: Speed cannot be measured because Speed does not exist, either!

Whilst the physical properties of Particle Spheres can be measured, they cannot be constrained by Human psychological insecurities - Momentum is 'Change', not 'Speed'!

Time and Speed can still be useful in Day-to-Day life, and even 'Minor Physics' (Physics in its present incarnation), for mundane Formulas and Equations; but for Physicists, and even all of Humanity, to reach advanced knowledge then Time and Speed must be forgotten.

Space Travel and Particle Spheres

Rather than understanding 'Travel' as 'Distance', 'Speed', and 'Time', Sphere Theory acknowledges Travel as a 'Thought Process'; the idea of dismantling and reconstructing Thoughts.

Rather than suggesting Traveling from 'Orbital-Sphere Earth' to 'Minor Orbital Sphere the Moon', we would need to suggest Traveling from 'Minor-Sphere the relevant Solar-System' to 'Minor-Sphere the relevant Solar-System'; the relevant Minor-Sphere being the 'Lowest Common Denominator'.

By decompressing Particle Spheres at the point of departure and re-compressing Particle Spheres at the point of arrival; this process is instantaneous. It is the act of relocating Particle Spheres within the 'Lowest Common Denominator'

It is highly 'Probable' that other life-forms other 'Orbital-Spheres' (Bodies that revolve around Sun-Spheres), and other 'Minor-Spheres' (Solar-Systems), and other 'Super-Clusters' (Galaxies) have gained the advanced Physics knowledge of Sphere Theory. These Life-forms (Aliens) have visited all the Super-Clusters within the relevant Super-Sphere.

Evolution and Particle Spheres

Evolution is incorrect!

Particle Spheres and all subsequent 'Identities' do not Evolve, but 'Grow'!

Like a "Mustard Seed", but much smaller than such, our Super-Sphere began as a singular Particle Sphere. Planted in fertile soil; planted in a true Vacuum of 'Negative Space'.

Aliens and Particle Spheres

Within our known Super-Sphere (Universe) there is an unknown large quantity of 'Super-Clusters' (Galaxies) that embody an even larger number of 'Minor-Spheres' (Solar-Systems); and embodied within Minor-Spheres are 'Sun-Spheres' (Suns), and 'Orbital-Spheres' (Bodies that revolve around Sun-Spheres), and 'Minor Orbital-Spheres' (Bodies that revolve around Orbital Spheres).

There is no number that can be placed upon the amount of Orbital-Spheres that exist within our Super-Sphere. 'Probability Theory' overwhelmingly suggests that there are billions of Orbital-Spheres that have Life on them; a billion of them with Life identical to Earth; and billions with Life that the Mind cannot imagine.

Aliens - any Life Forms that exist within the Super-Sphere that is separate from the Orbital-Sphere, Earth.

All Aliens are subject to 'The Laws of Particle Spheres'!



Good and Evil

'The Natural' and 'The Supernatural' do not exist; more specifically, they are simply different variations of presence. What Humans perceive to be Supernatural are 'Those' that occupy different Frequencies and Vibrational levels; 'levels' higher and lower than our own state of being and consciousness.

'Those' that occupy different Frequencies and Vibrational levels are only able to do so because Particle Spheres have components of their composition that are within those relevant Frequencies and Vibrational levels; or rather, as Particle Spheres Condense, Expand, Merge and Divide they create Friction, Vibrations, Heat, and Light, and all the relevant Frequencies.

All Those that occupy such Frequencies have no more and no less integrity and/or morality than any other Identity(s) within the Super Sphere. Just as Humans bully, beat, torment, and murder other Humans, and our animal companions, so does all other Identities within the Super Sphere have those amongst them that have intent that is not of a standard that Humans would categorize as 'moral'.

There are Those of 'wrong intent' that have the ability to travel between Minor-Spheres (Solar-Systems) and even Super-Clusters (Galaxies). However, some have the 'ability' as simply a component of their design; whilst others have the 'ability' as component of their design, but also the knowledge and understanding of the 'ability' - the advanced understanding of Particle Spheres and the use of such for Travel.

Integrity and Morality are not governed by Location, Vibration, or Frequency!



Extended Sphere Theory

Theory #1

'Probability' suggests that Particle Spheres may reproduce by way of division by halves.

Thus, within this 'Probability' there are four (4) probable conclusions:

* Expansion of the Super-Sphere (Universe) to accommodate the embodied dividing Particle Spheres.

* The Super-Sphere is not expanding but simply increasing in Density and Pressure as the embodied Particle Spheres divide and grow.

This action would have catastrophic consequences by way of pressure on the circumference of the Super-Sphere, thus causing the Super-Sphere to explode.

* The Super-Sphere expands but at a slower rate than the embodied dividing Particle Spheres.

This action would still have catastrophic consequences by way of pressure on the circumference of the Super-Sphere, thus causing the Super-Sphere to explode.

* The Super-Sphere expands but at a faster rate than the embodied dividing Particle Spheres.

This action would again have catastrophic consequences by way of vacuum-like pressure on the embodied dividing Particle Spheres, thus causing the embodied Particle Spheres to explode.

My theory is that Particle Spheres would need to divide at a stage that is at least two times (2x) the 'Natural' state; thereby creating two (2) identical Natural Particle Spheres.

It may possibly be that Particle Spheres divide at the 'Condensed' state (100% Density); thereby creating two (2) 'Baby Particle Spheres'.

Theory #2

'Possibility' suggests that Particle Spheres may reproduce by way of internal conception, as 'Internal Instructions' dictate.

Theory #3

'Possibility' suggests that external to the Super-Sphere (Universe) there may be a 'true Vacuum'; hence, the Super-Sphere outer circumference would be protecting the entire Universe there within from the immense Vacuum Pressure.

Theory #4

'Possibility' suggests that there may be more than one Super-Sphere (Universe). Furthermore, the number of Super-Spheres may be such that is incalculable.

Theory #5

'Possibility' suggests that Super-Spheres may be able to divide; and what is thought to be Parallel Universes by modern Physics may in fact be 'Twin Sister Super-Spheres'.

Theory #6

'Possibility' suggested that there may be 'Tumor-Spheres', which is a Super-Sphere that exists within a Super-Sphere - a Universe within a Universe.

If a Tumor-Sphere expands at a faster rate than the Host Super-Sphere, then this action would have catastrophic consequences by way of building pressure within the Host Super-Sphere, thus causing the Host Super-Sphere to explode.

Theory #7

By gaining the advanced Physics knowledge of Sphere Theory we can visit all the Super-Clusters within the relevant Super-Sphere.; but more than

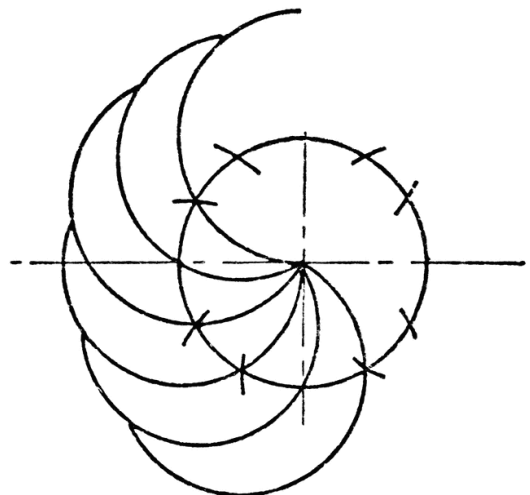

this we can be in two separate locations at the same moment. In fact, 'Possibility' suggests that the quantity of simultaneous locations for any one person could be limitless.

The Akhenaten Theorem

The knowledge of 'Consciousness' and the 'Breath of Life', and the operations of such.

'Consciousness' is not dependent on the Density of Combined, or Clustered, or singular Particle Spheres, or the Radius of the same.

The customization and 'giving' of Consciousness is beyond the understanding of the customization of Consciousness that we have been given; namely, the Human Mind and the relevant 'Observer' were never designed to have such understanding. This design element is not a flaw, but it was simply thought that the need for such understanding was not relevant to the design.

* No man can exist naked within an endless true Vacuum and create, unless he thinks to use parts of his own body to create, and subsequently does such. That which he creates will come from his own 'Flesh and Blood'; and he will lose a percentage of his body.

The man's creation is now before him, and it is decomposing; in fact, the Flesh began decomposing at the moment it was removed from the Body. Dead Flesh requires the 'Breath of Life' to slow the decomposition; and an 'Observer', and a degree 'Consciousness'.

'The Akhenaten Theorem' suggests that highest Consciousness(s) cannot be comprehended by the lowest Consciousnesses. 'The Consciousnesses(s)' ...

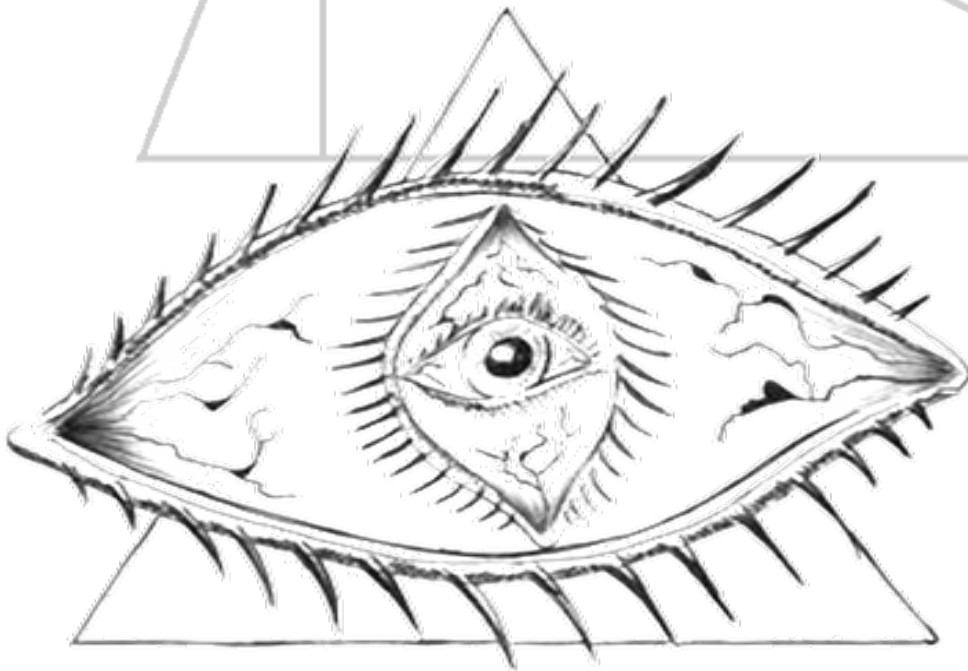

Final

Sphere Theory is a whole new field of Physics that is, in reality, far beyond Theoretical Physics. Sphere Theory is Physics in its most advanced form; yet, it is Physics in its most beautiful form; it is Physics in its most Natural and Organic form.

Sphere Theory is the future of Physics, and 'The Way' to finding 'The Key' to unlocking Mysteries and Riddles that have plagued Humans since the beginning of known History; both those Mysteries that are within us, and those Mysteries that are at the edge of the Super-Sphere (Universe).

I have now presented my initial findings on Sphere Theory, but certainly only the smallest fraction of the subject.

